

8h30
2/3 11pts

SIMPLE MASCULIN BENJAMIN

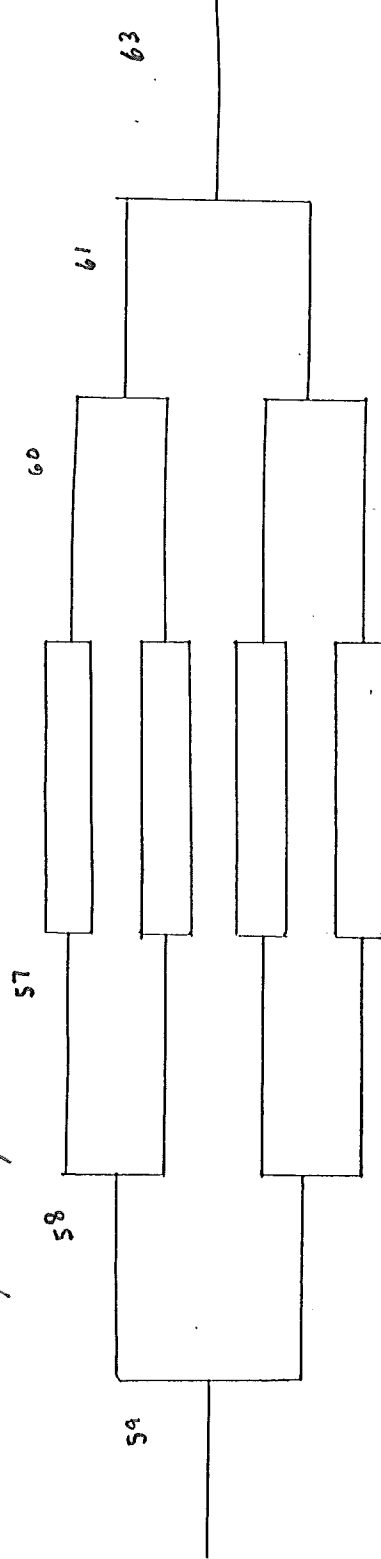

TOUS LES JOUEURS DOIVENT JOUER UN MINIMUM DE DEUX PARTIES PAR ÉPREUVE

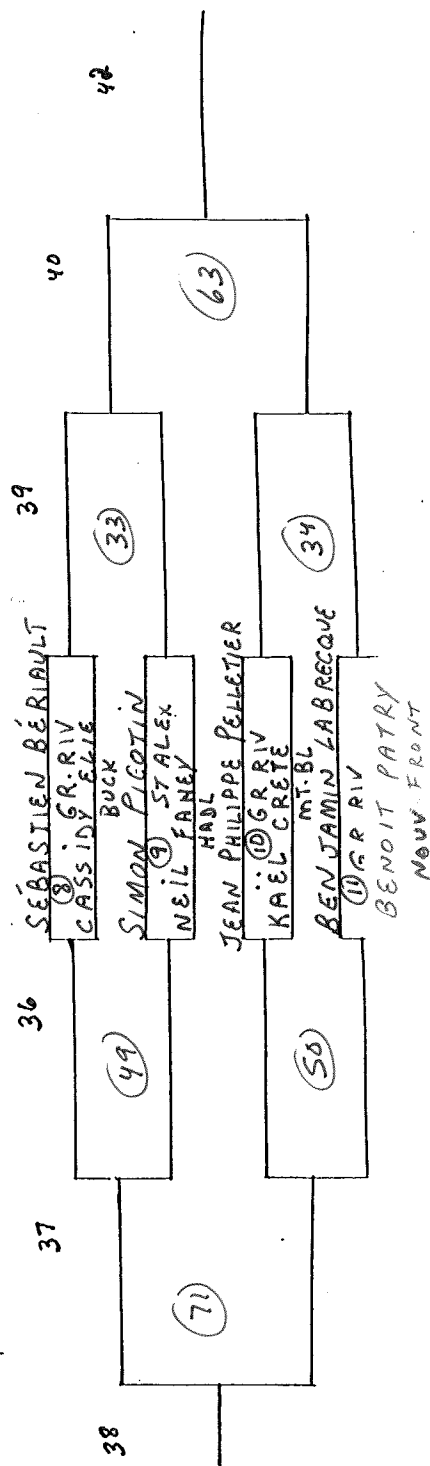
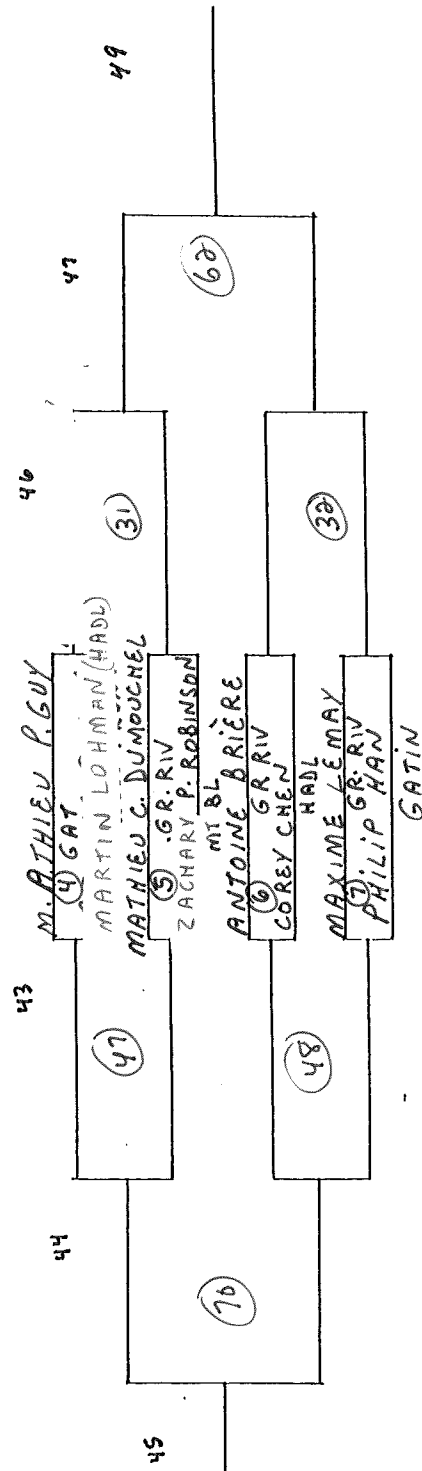
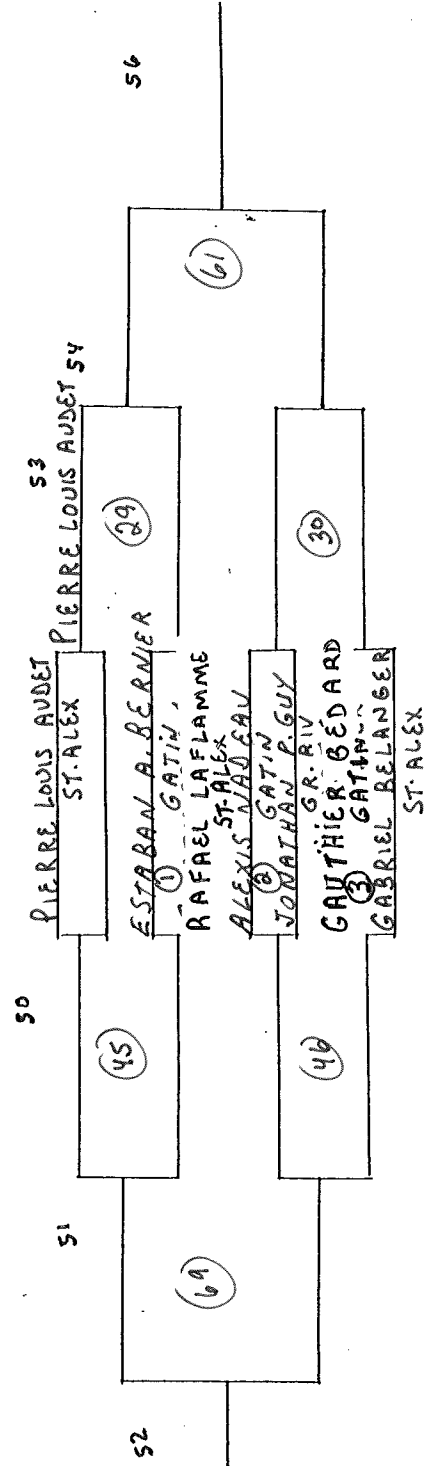

8 h 30
2/3 11 pt6

SIMPLE MASCULIN BENJAMIN

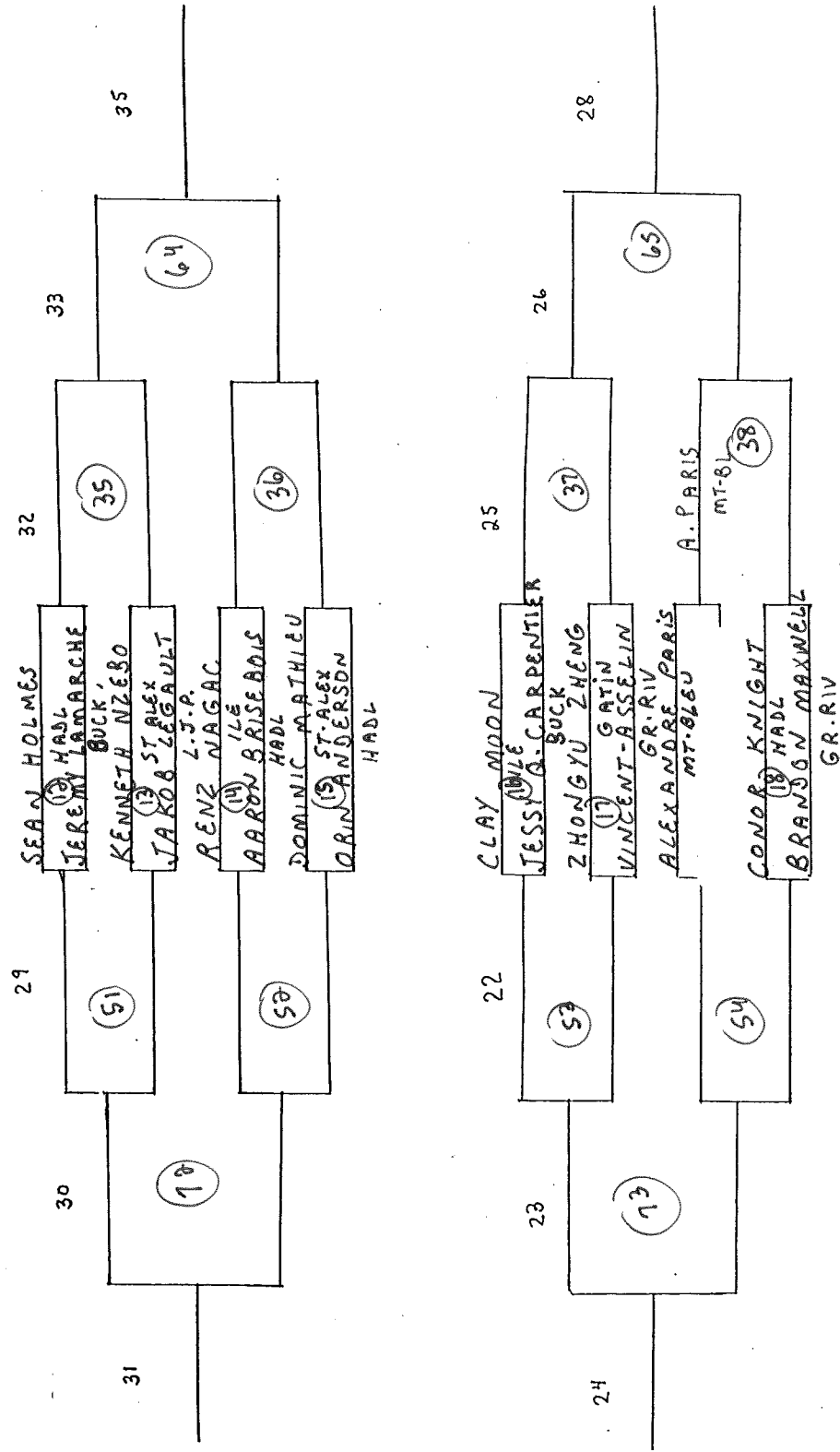

TOUS LES JOUEURS DOIVENT JOUER UN MINIMUM DE DEUX PARTIES PAR ÉPREUVE

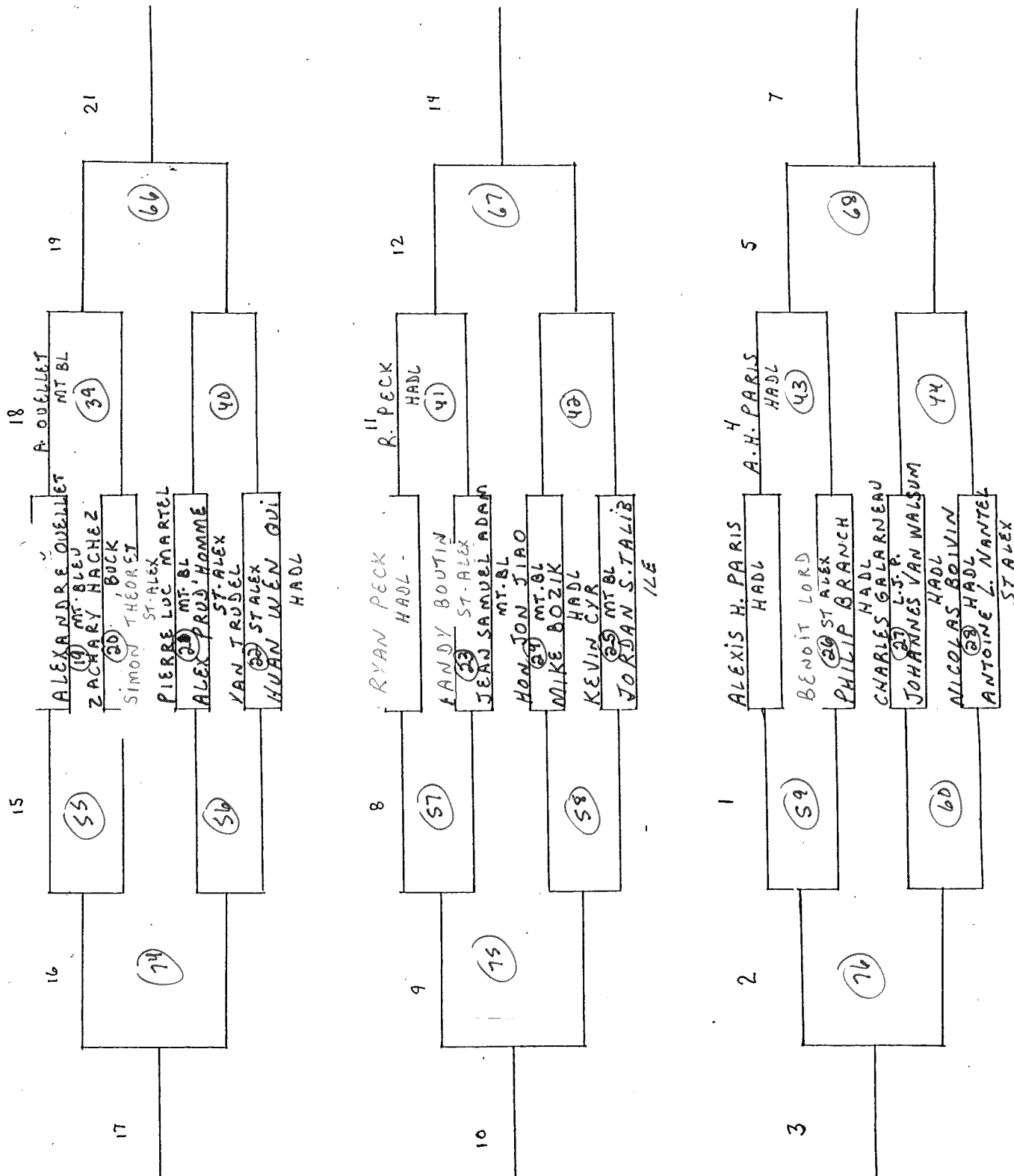

12h00

SIMPLE MASCULIN CADET

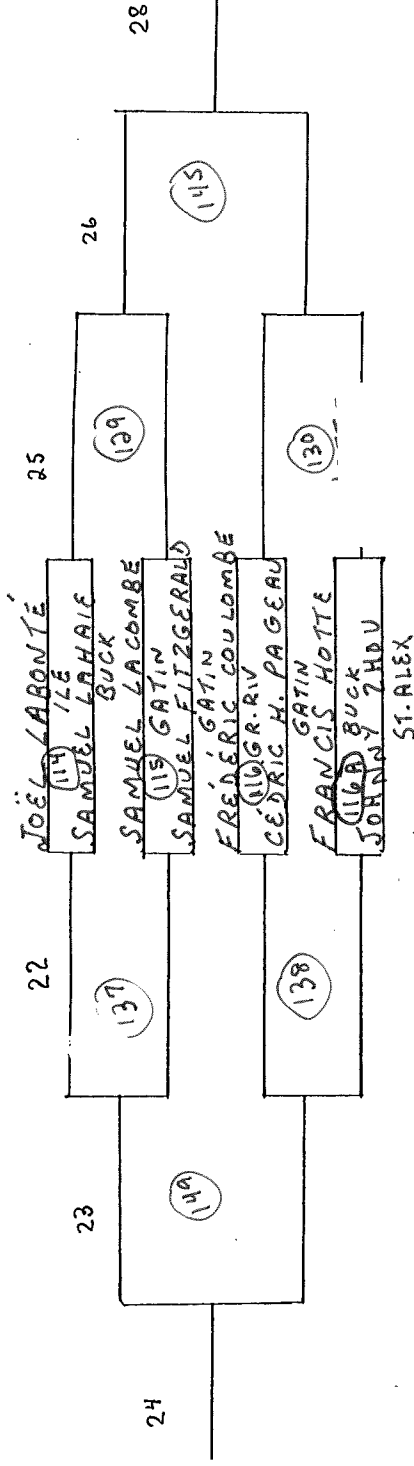

TOUS LES JOUEURS DOIVENT JOUER UN MINIMUM DE DEUX PARTIES PAR ÉPREUVE

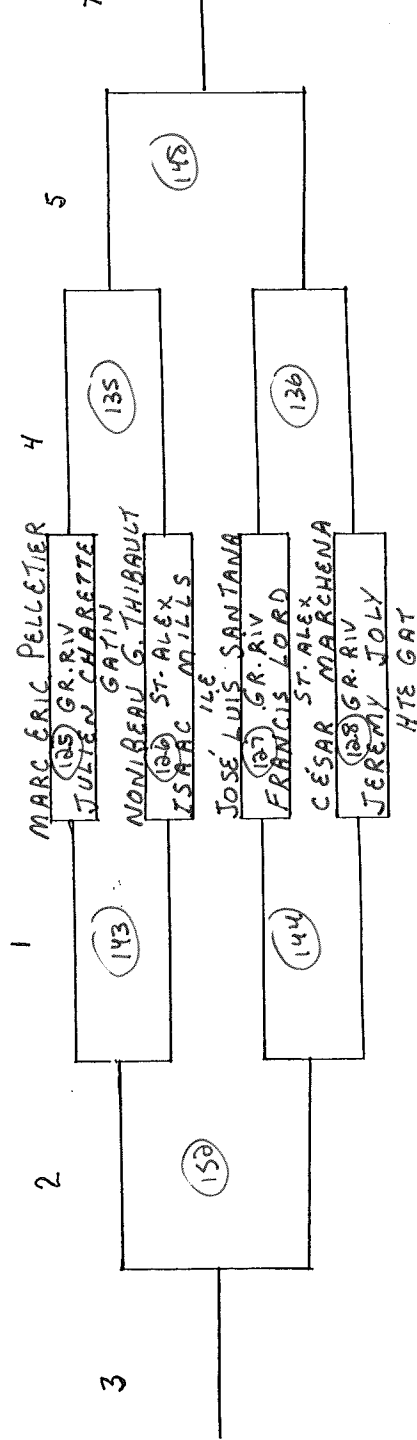
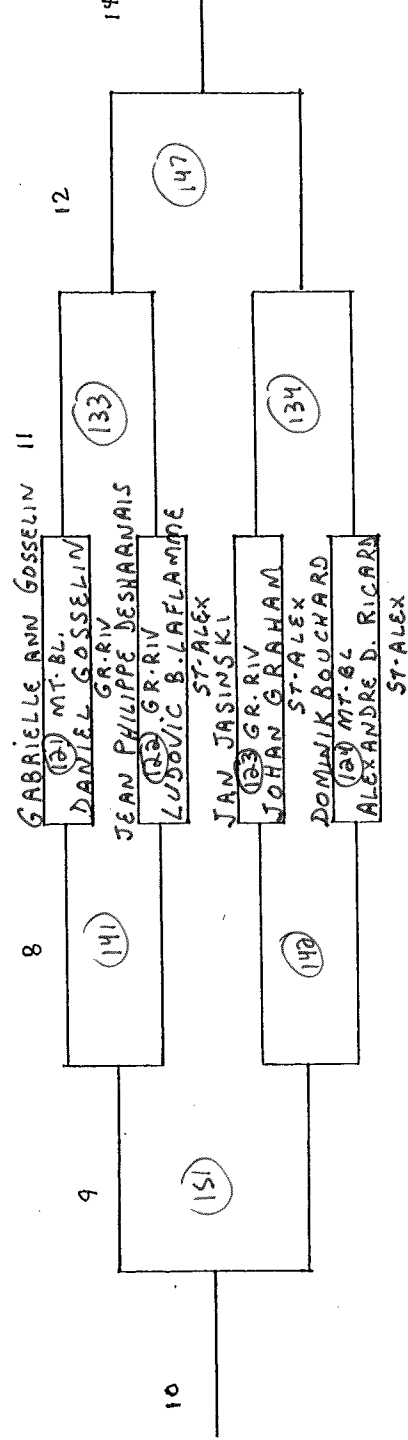
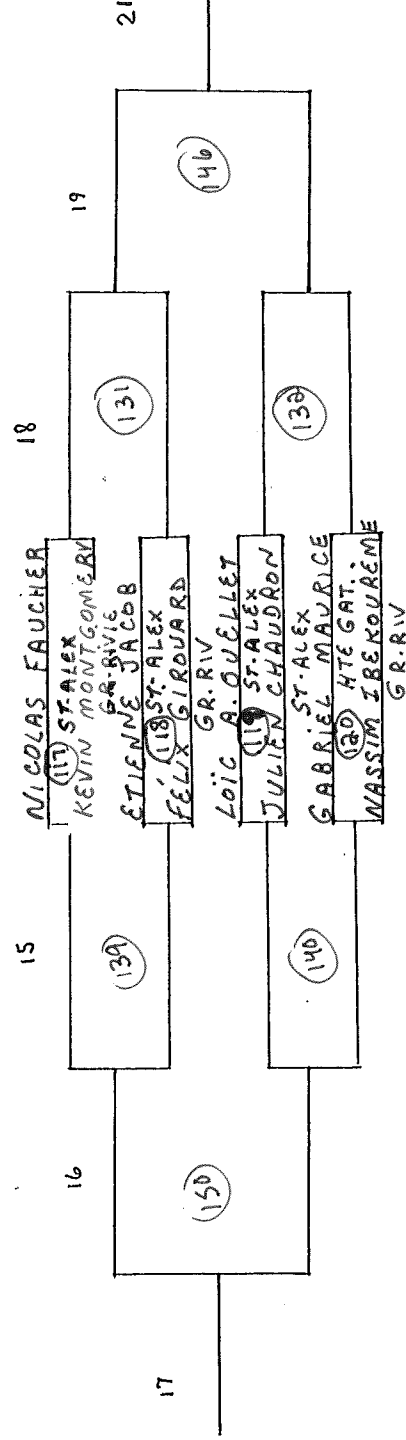

DOUBLE MASCULIN CADET

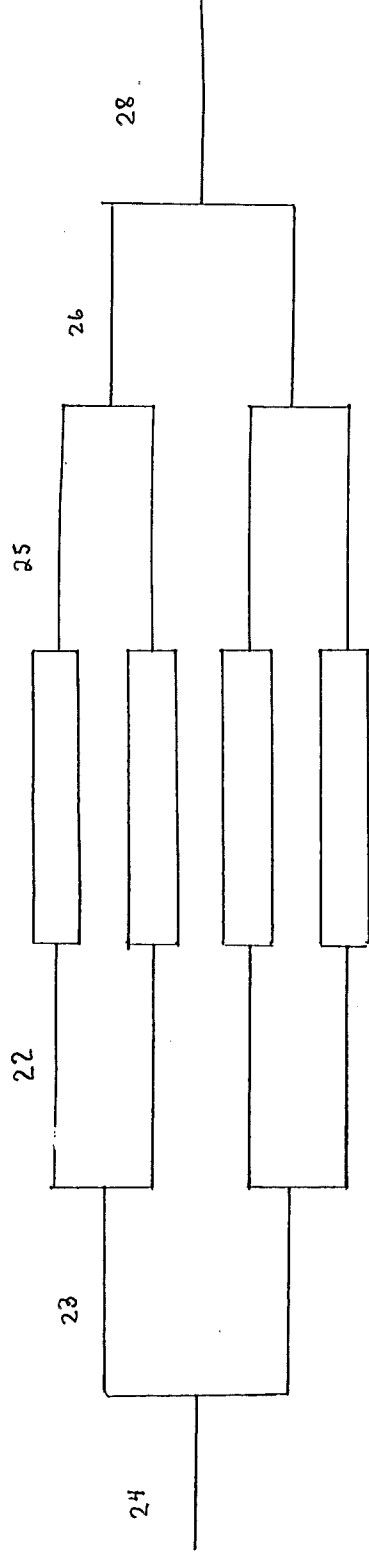

TOUS LES JOUEURS DOIVENT JOUER UN MINIMUM DE DEUX PARTIES PAR ÉPREUVE

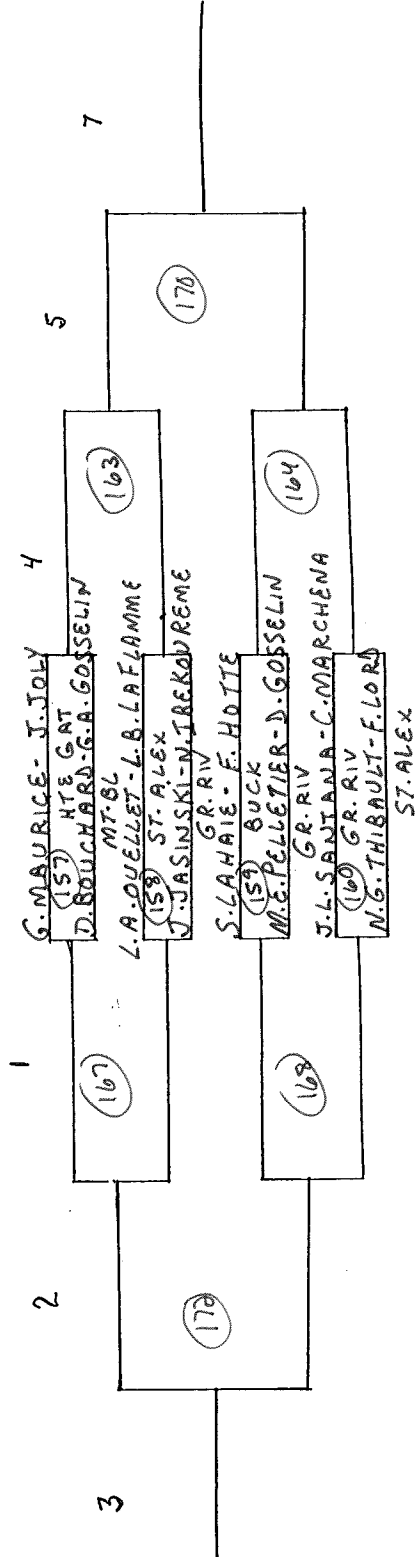
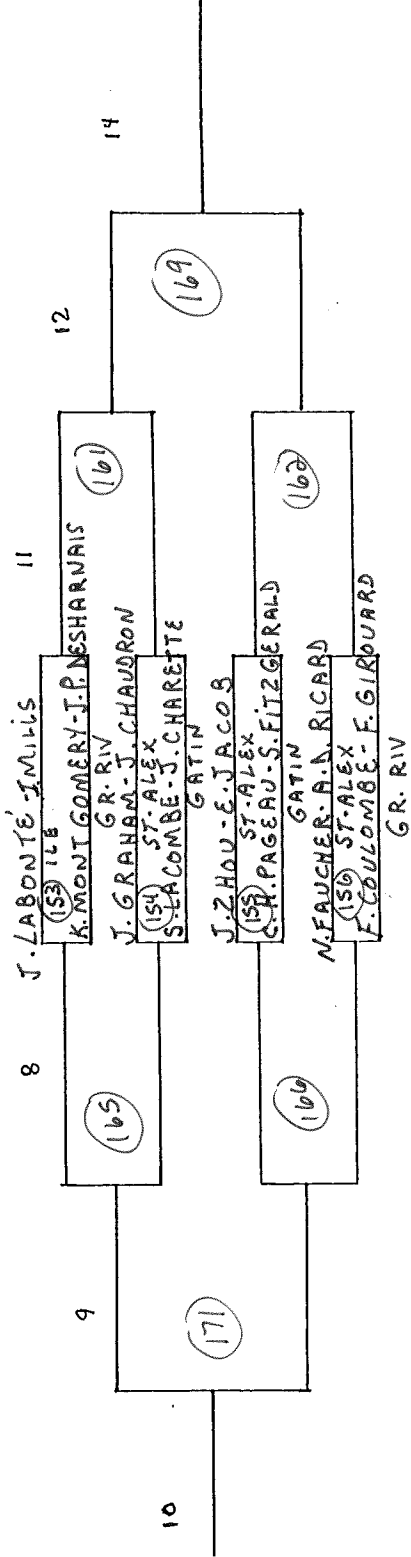
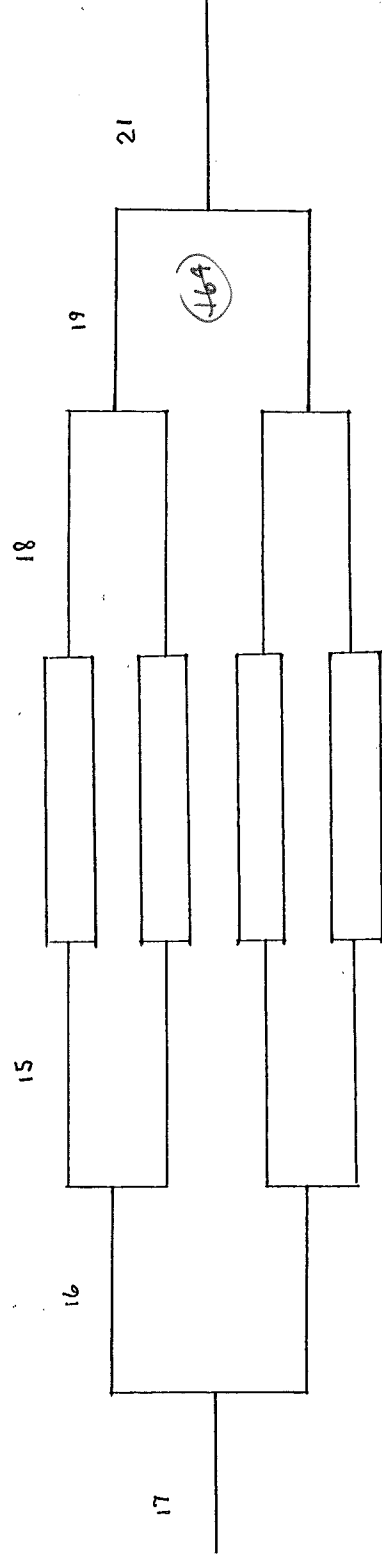

DOUBLE MASCULIN JUVENILE

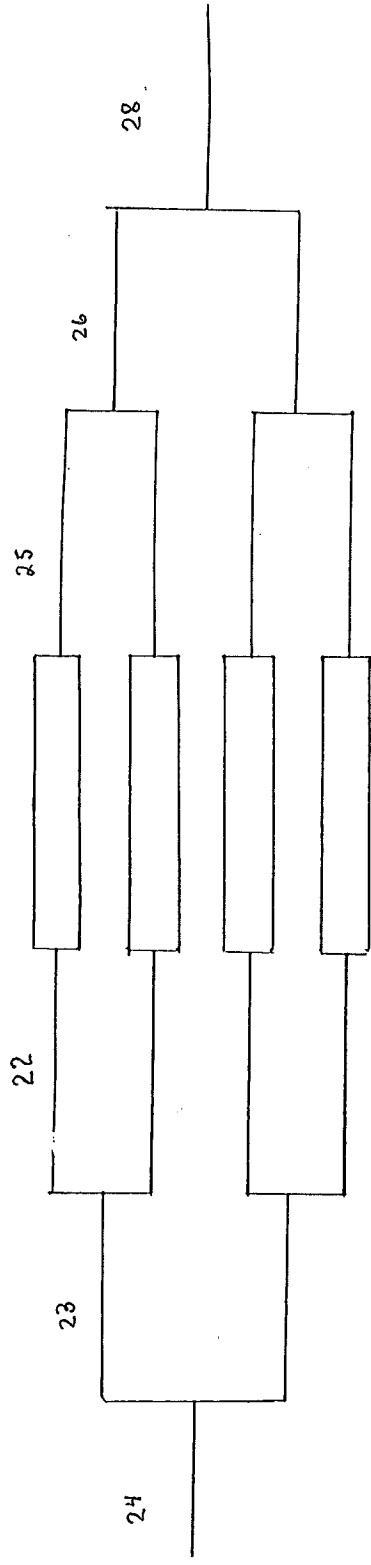

TOUS LES JOUEURS DOIVENT JOUER UN MINIMUM DE DEUX PARTIES PAR ÉPREUVE

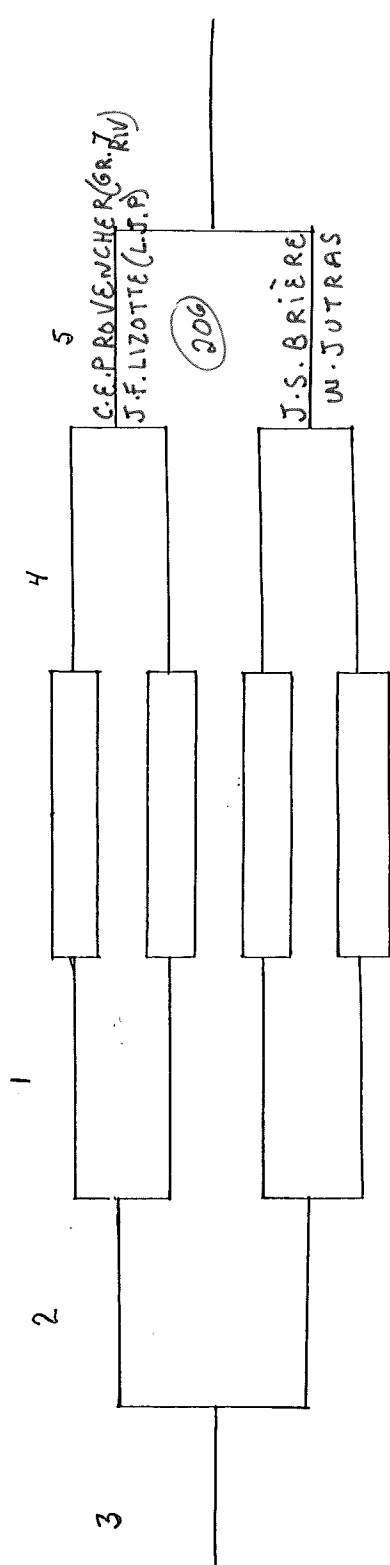
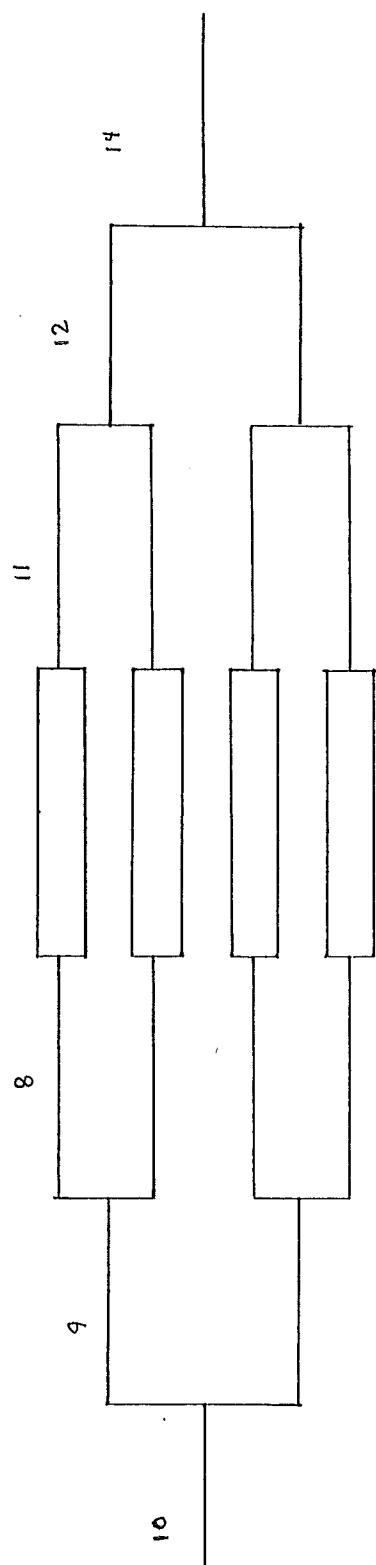
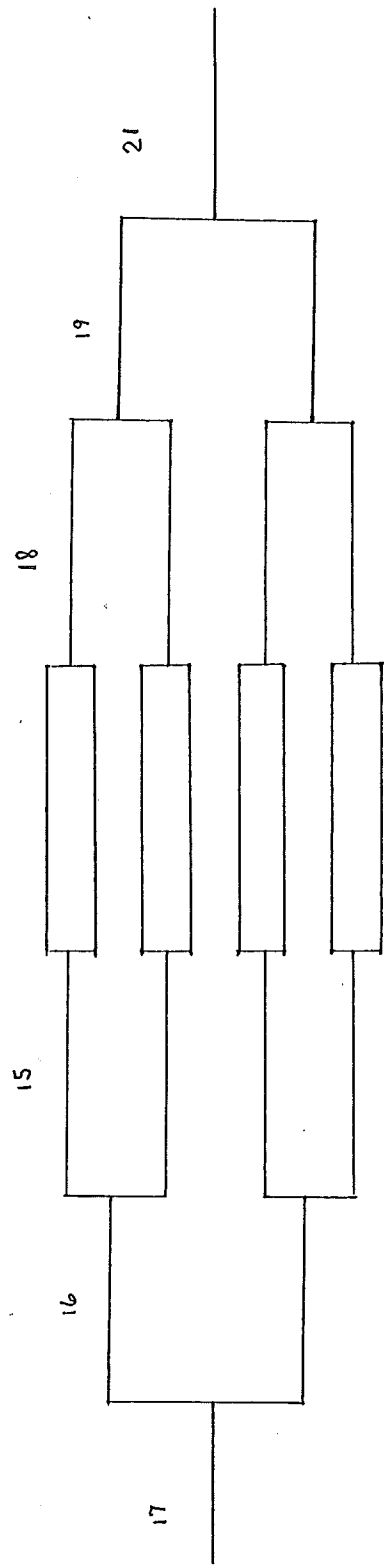

13h30

SIMPLE MASCULIN MOUSTIQUE

2/3 11 pts

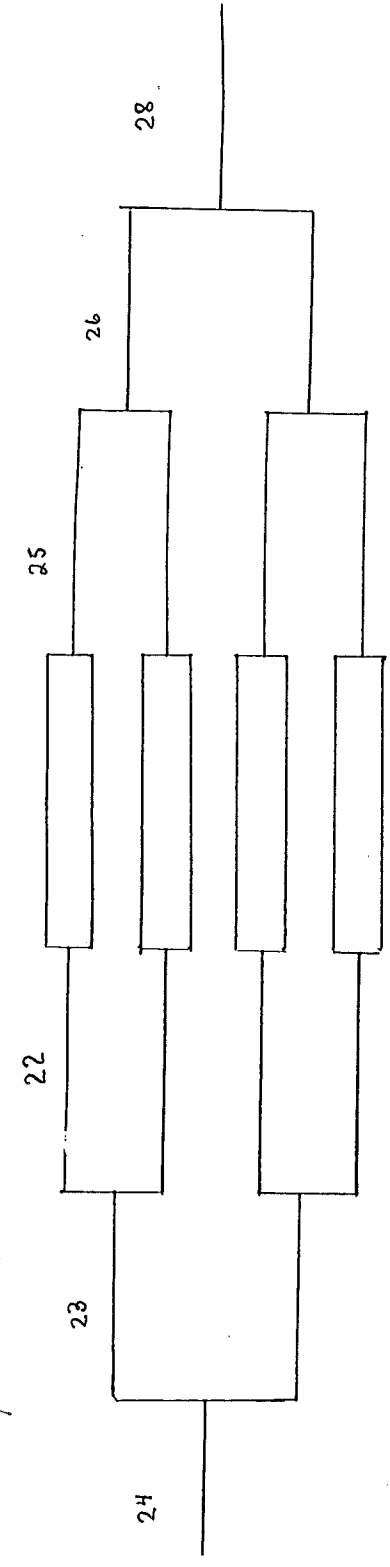

TOUS LES JOUEURS DOIVENT JOUER UN MINIMUM DE DEUX PARTIES PAR ÉPREUVE

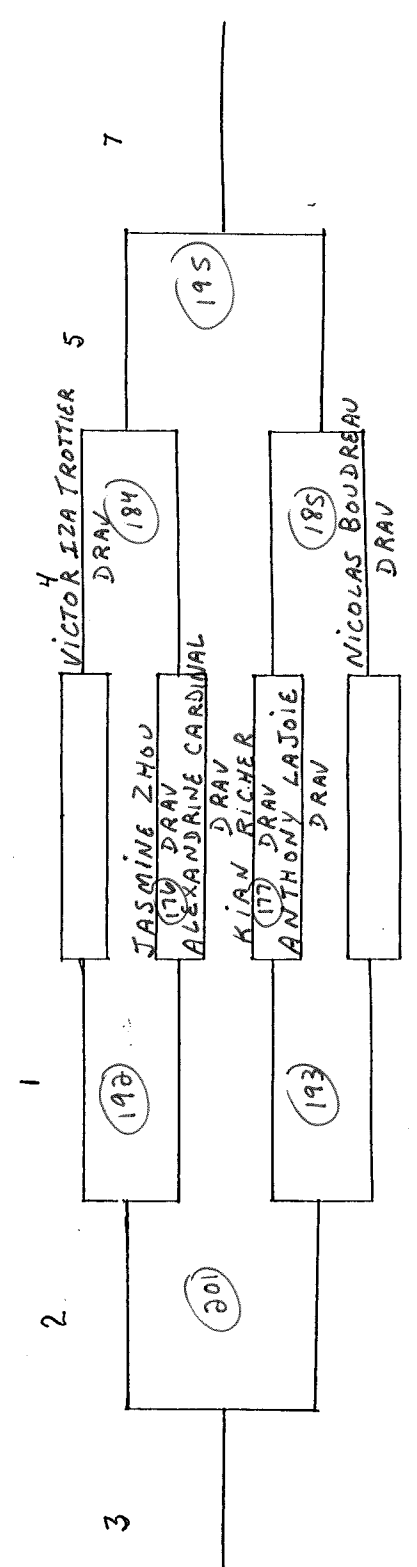
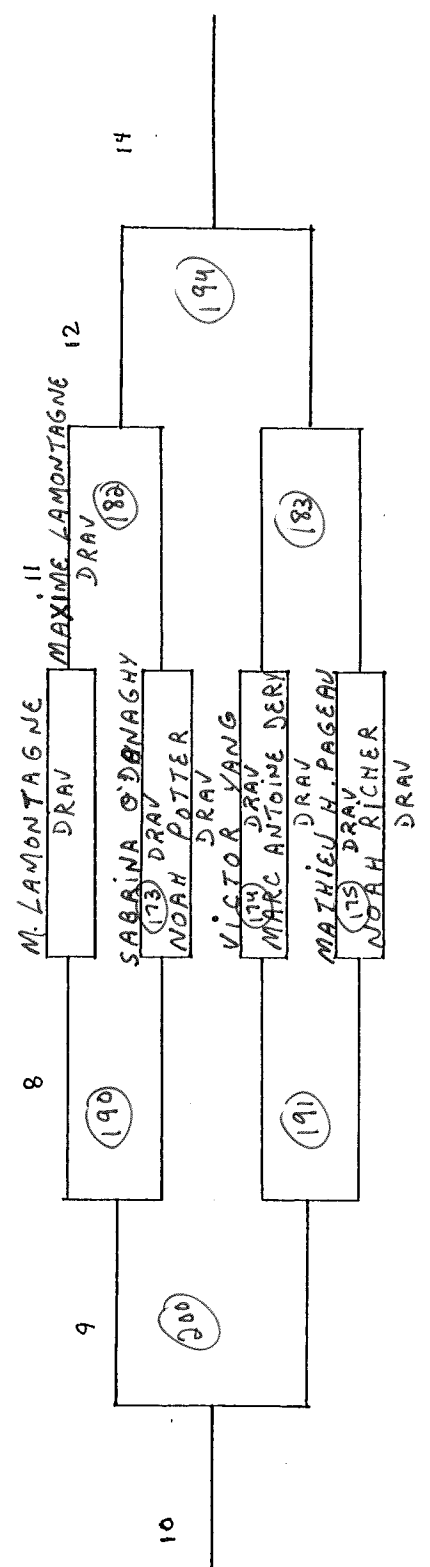
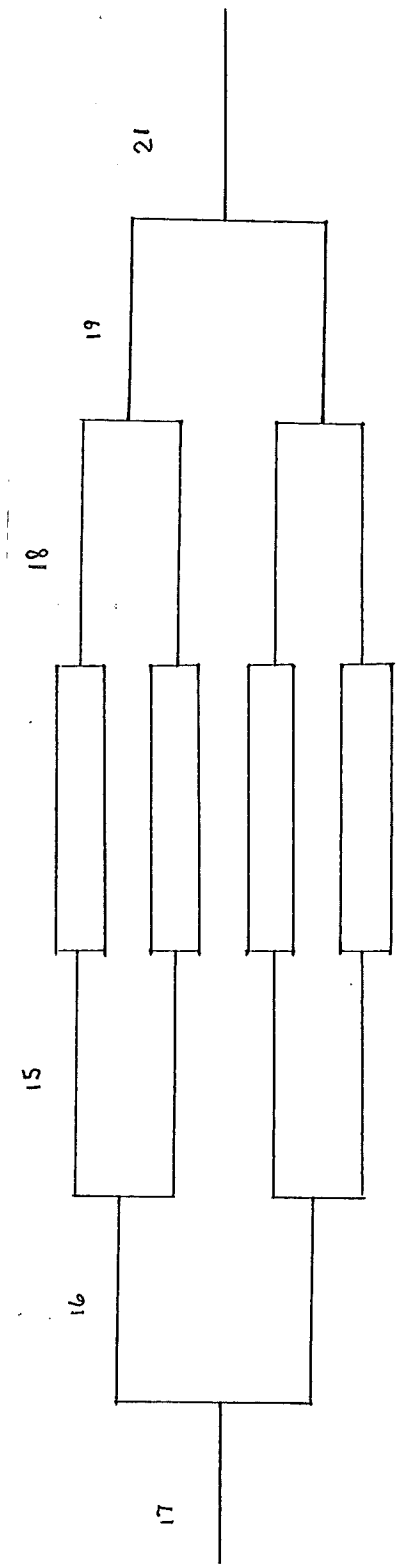



SPORT ÉTUDIANT

13 h 30
2/3 11 pts

DATE : _____

CATEGORIE : JUVENILE

EPREUVE : SIMP. MASC.

DIVISION : _____

	NOMS	ECOLES	1	2	3	4	V	D	PTS	RANG
1	CHARLES ETIENNE PROVENCHER	GR. RIV.								
2	JEAN SEBASTIEN BRIERE	BUCK	(198)							
3	JEAN FRANCOIS LIZOTTE	L.J.P	(188)	(18)						
4	WILLIAM JUTRAS	BUCK	(180)	(189)	(199)					

ORDRE DE PASSAGE : 1-4;2-3 / 1-3;2-4 / 3-4;1-2 ;

DOUBLE FÉMININ JUVÉNILE

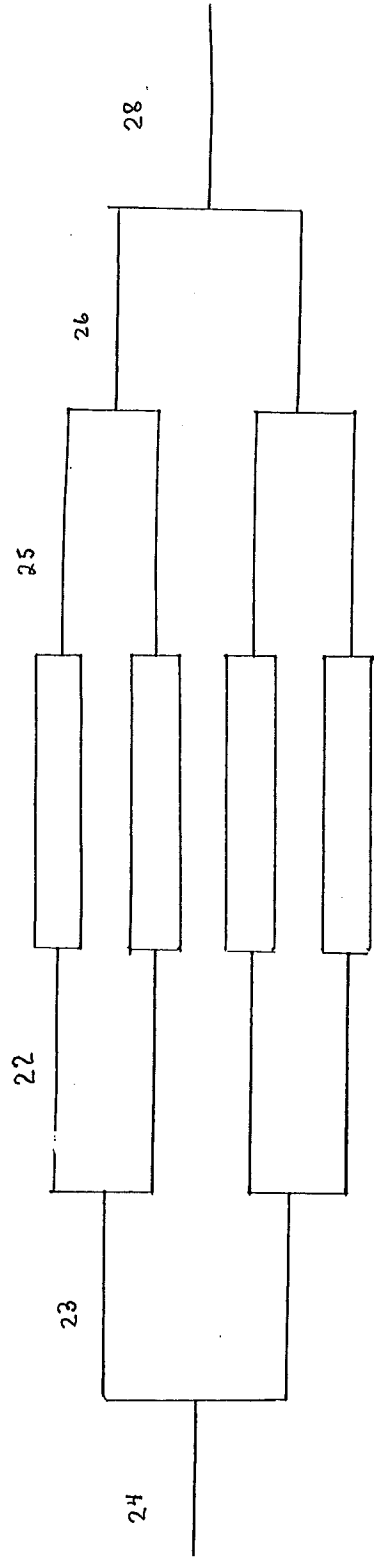

TOUS LES JOUEURS DOIVENT JOUER UN MINIMUM DE DEUX PARTIES PAR ÉPREUVE

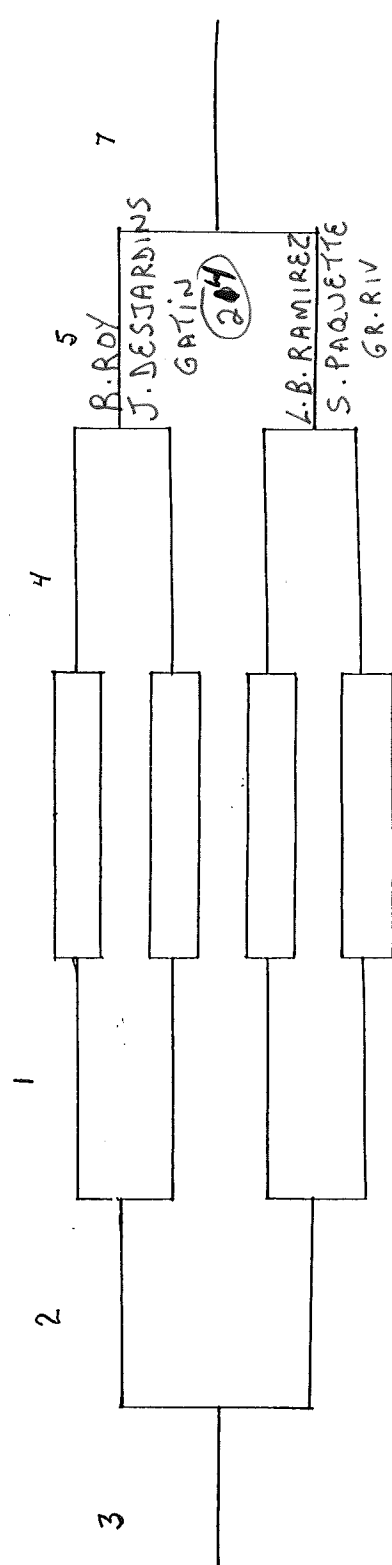
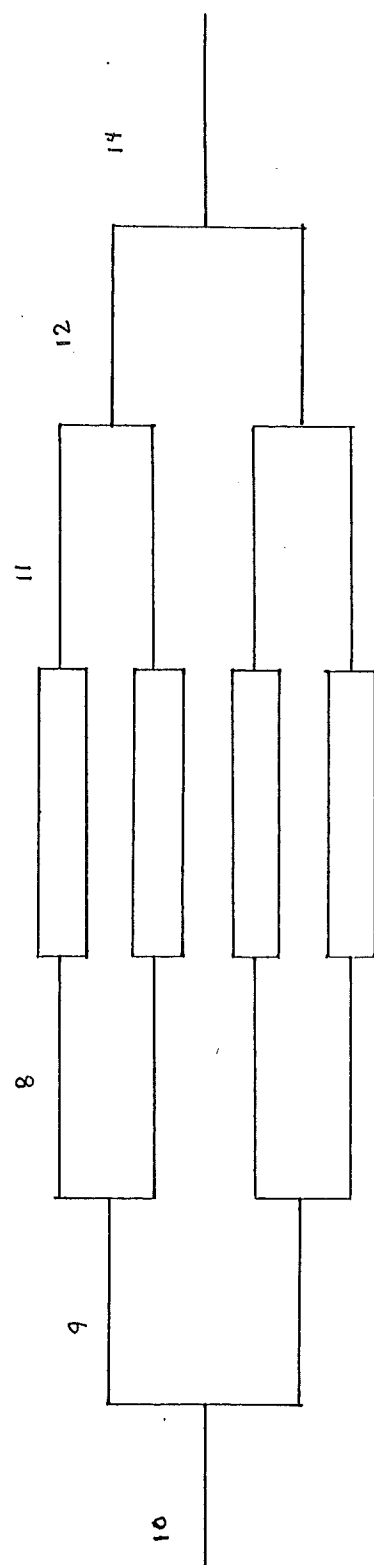
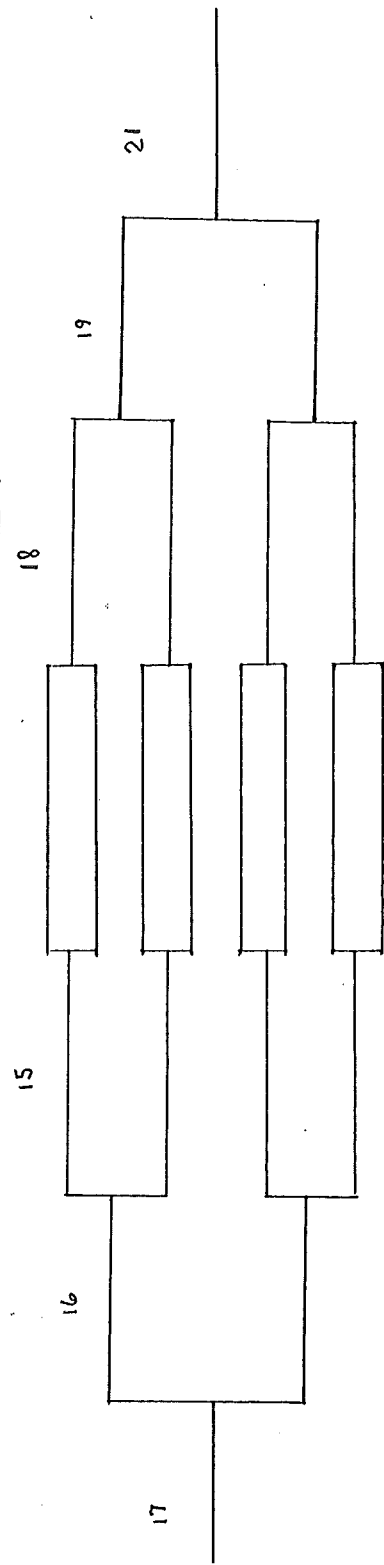

DOUBLE MASCULIN MOUSTIQUE

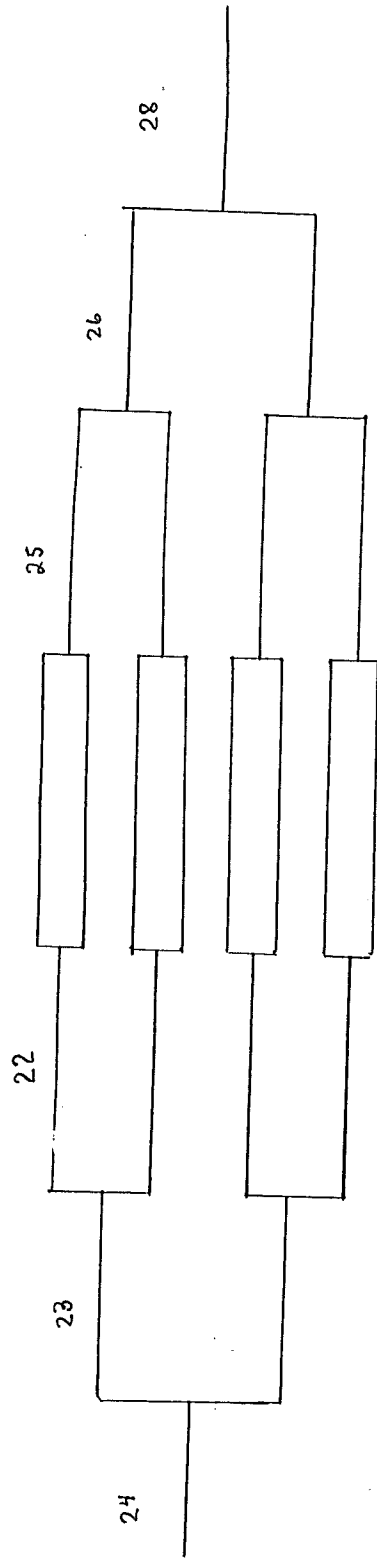

TOUS LES JOUEURS DOIVENT JOUER UN MINIMUM DE DEUX PARTIES PAR ÉPREUVE

